



Geodetic Infrastructure and Procedures for Vertical Land Motion & Sea Level Rise monitoring

Current Capabilities and Future Solutions

UN-GGCE - "Joining Land and Sea" December 2024, Bogor, Indonesia

Alex Lapadat

PhD Candidate, Mathematical Geodesy and Positioning group, TU Delft, Netherlands

Advisor: prof. dr. Ramon Hanssen



Collaborators:

NL: S. van Diepen, F. van Leiejn, B. Alberts, B. van Goor, L. Huisman, H. van der Marel, T. Kremers, H. Ekkelenkamp; SG: E. Mulder, L. Y. Mok, V. Khoo, T. Ny, F. Lujia;

ID: H. Andreas, B. Triyogo, B. Bramanto, O. Maulita, I. Septiawan, B. Triarahmadhana;

Capabilities: Techniques & Infrastructure

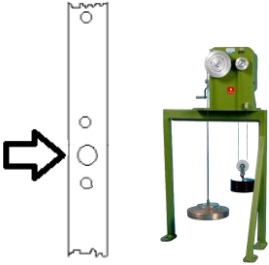
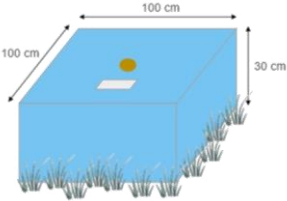
Geodetic techniques & infrastructure measuring elevations

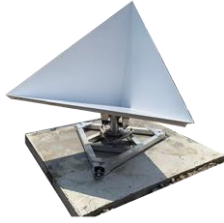
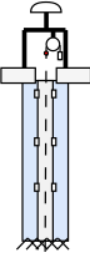
Techniques	Spirit Leveling	Tide Gauges	Absolute Gravimetry	GNSS	InSAR	Extensometry
Infrastructure						
Limitations	Elevation difference btw bolts/ points	Water level change wrt. physical mark	Gravity of a bolt/ point	Position fictive point of the antenna	Displacement wrt. fictive pixel	Displacement wrt. to physical mark

The development of Geodetic Infrastructure by Technique

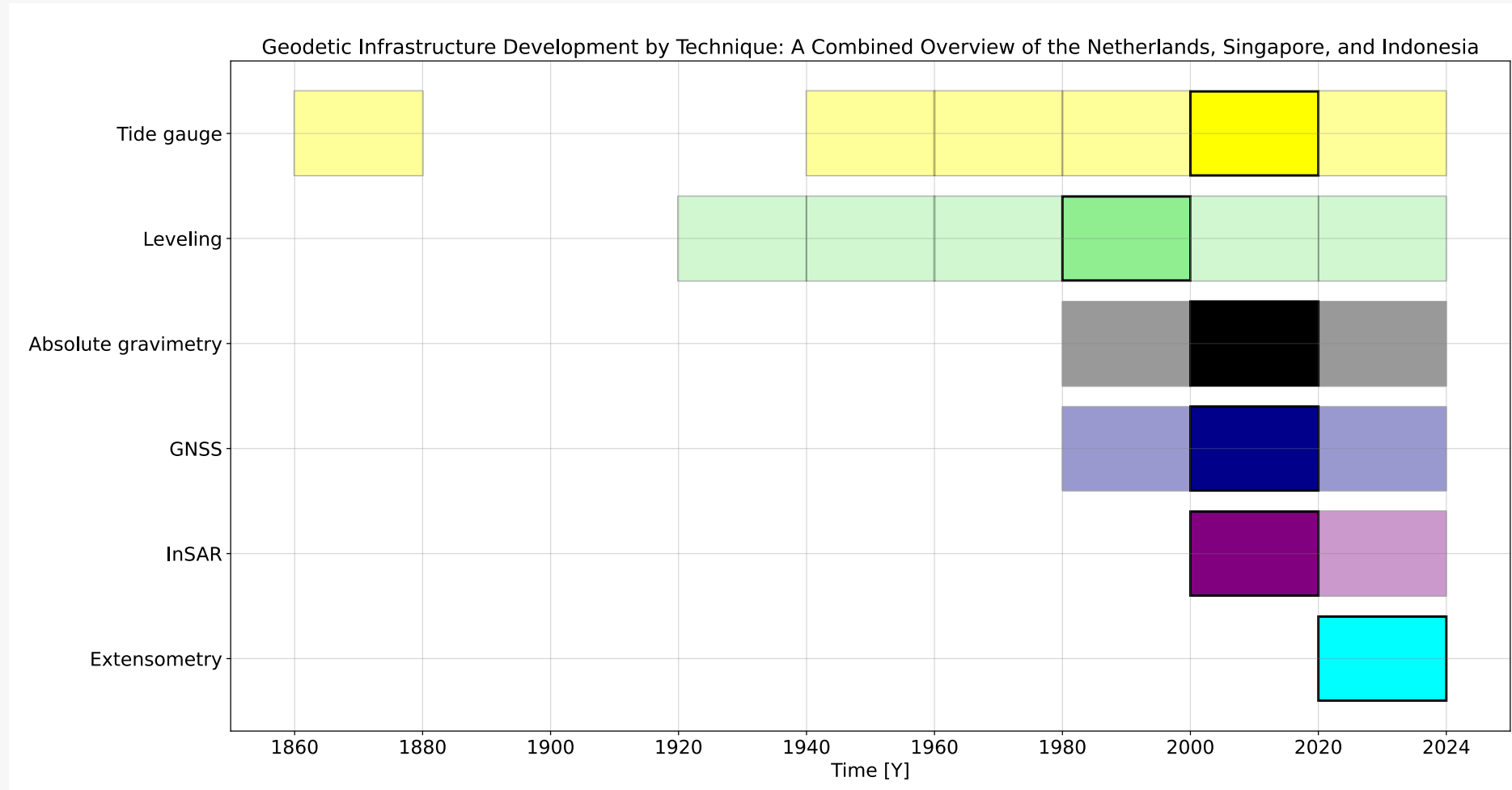

The development of Geodetic Infrastructure by Technique

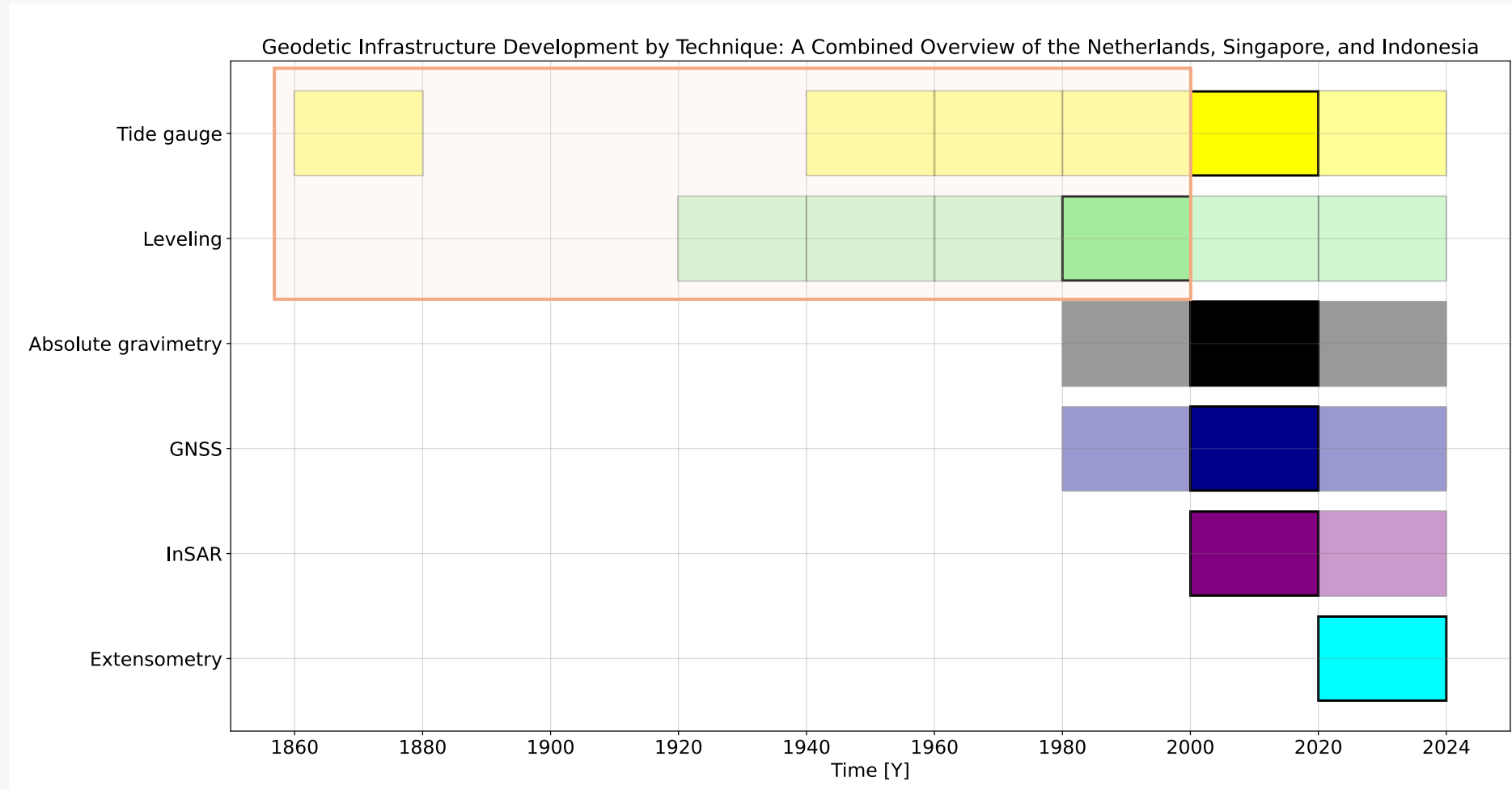

The development of Geodetic Infrastructure by Technique

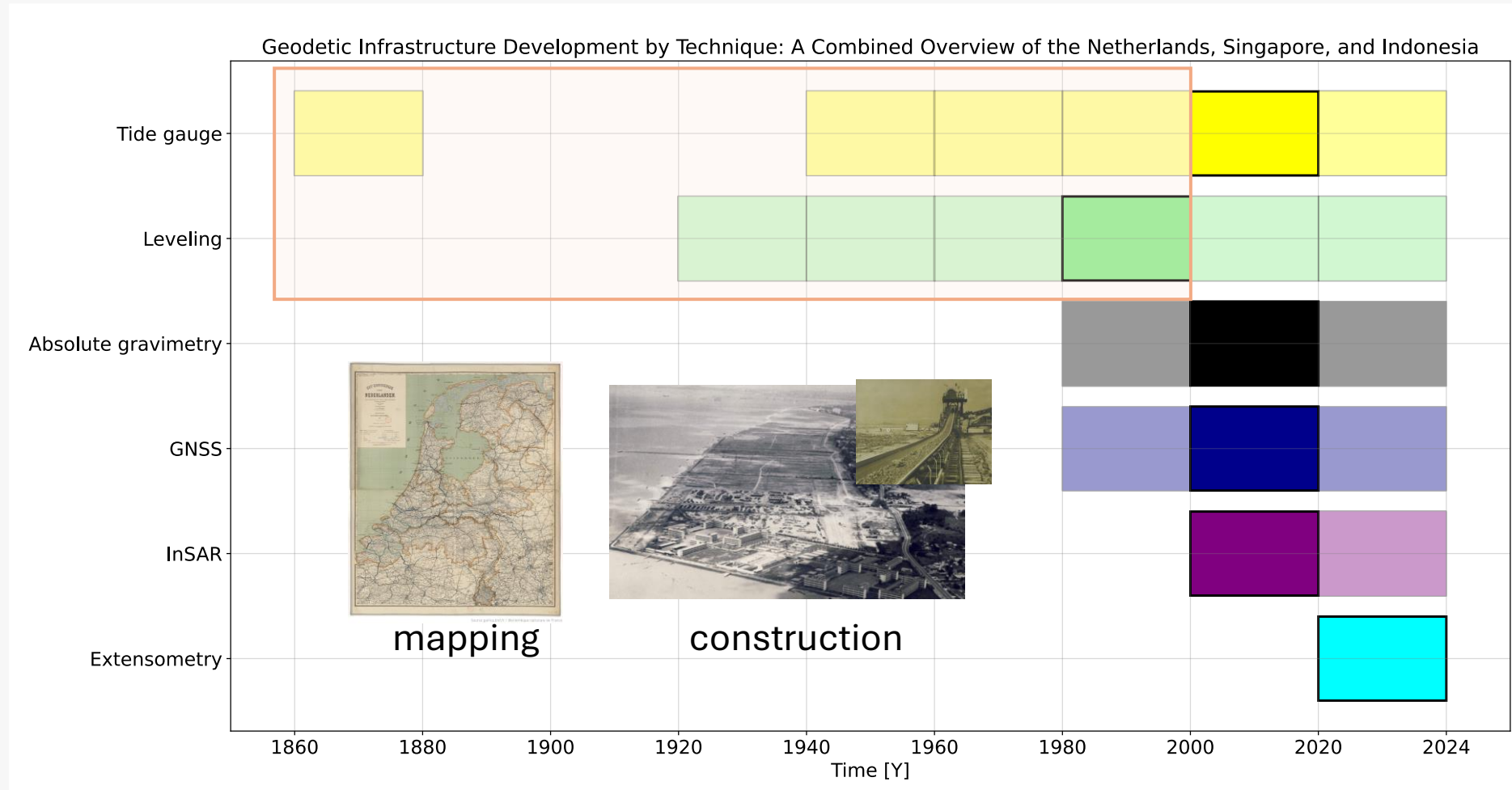

1860-2000: establishing leveling based vertical reference frames for mapping and construction applications.

The development of Geodetic Infrastructure by Technique

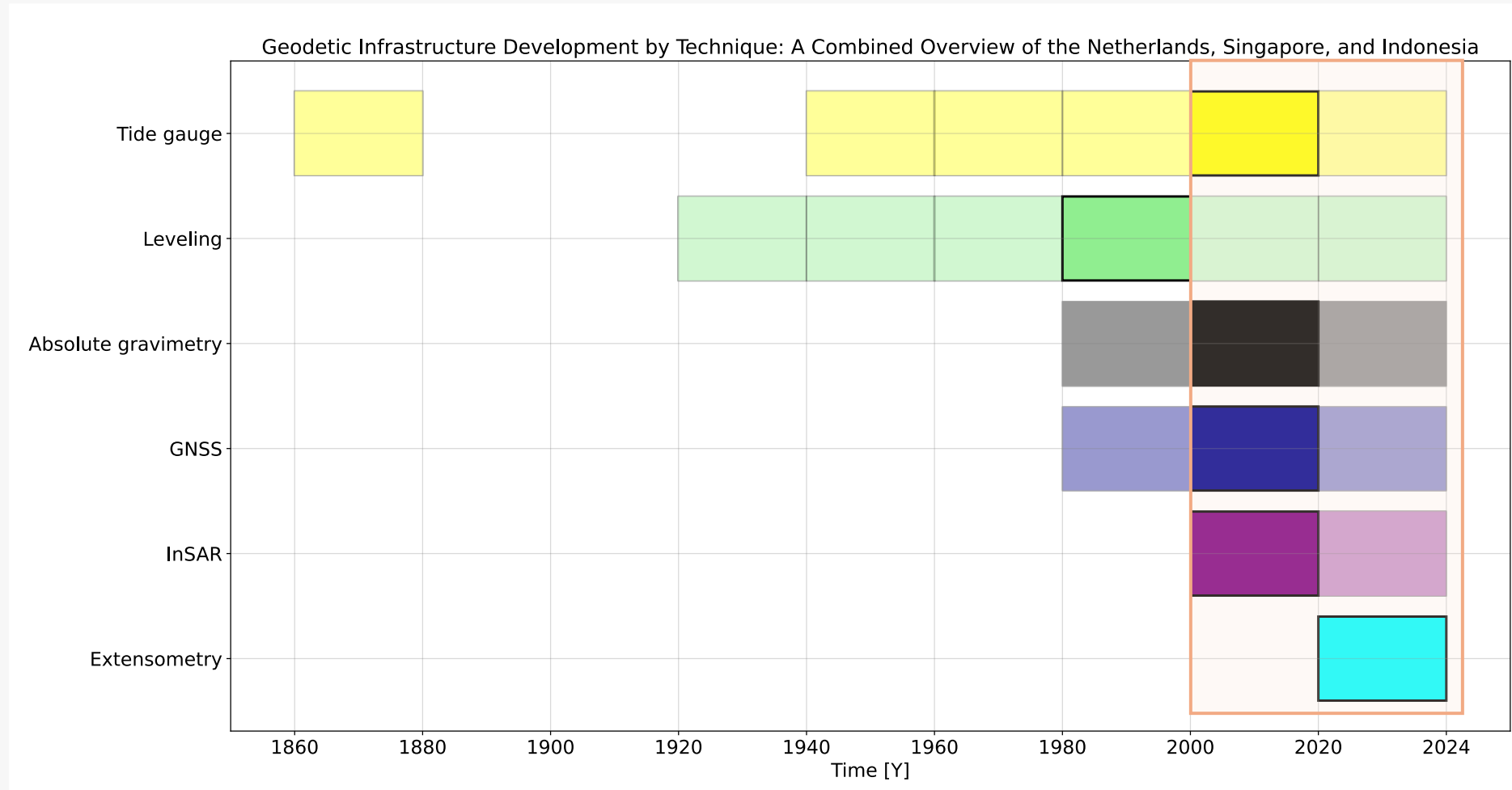

The development of Geodetic Infrastructure by Technique

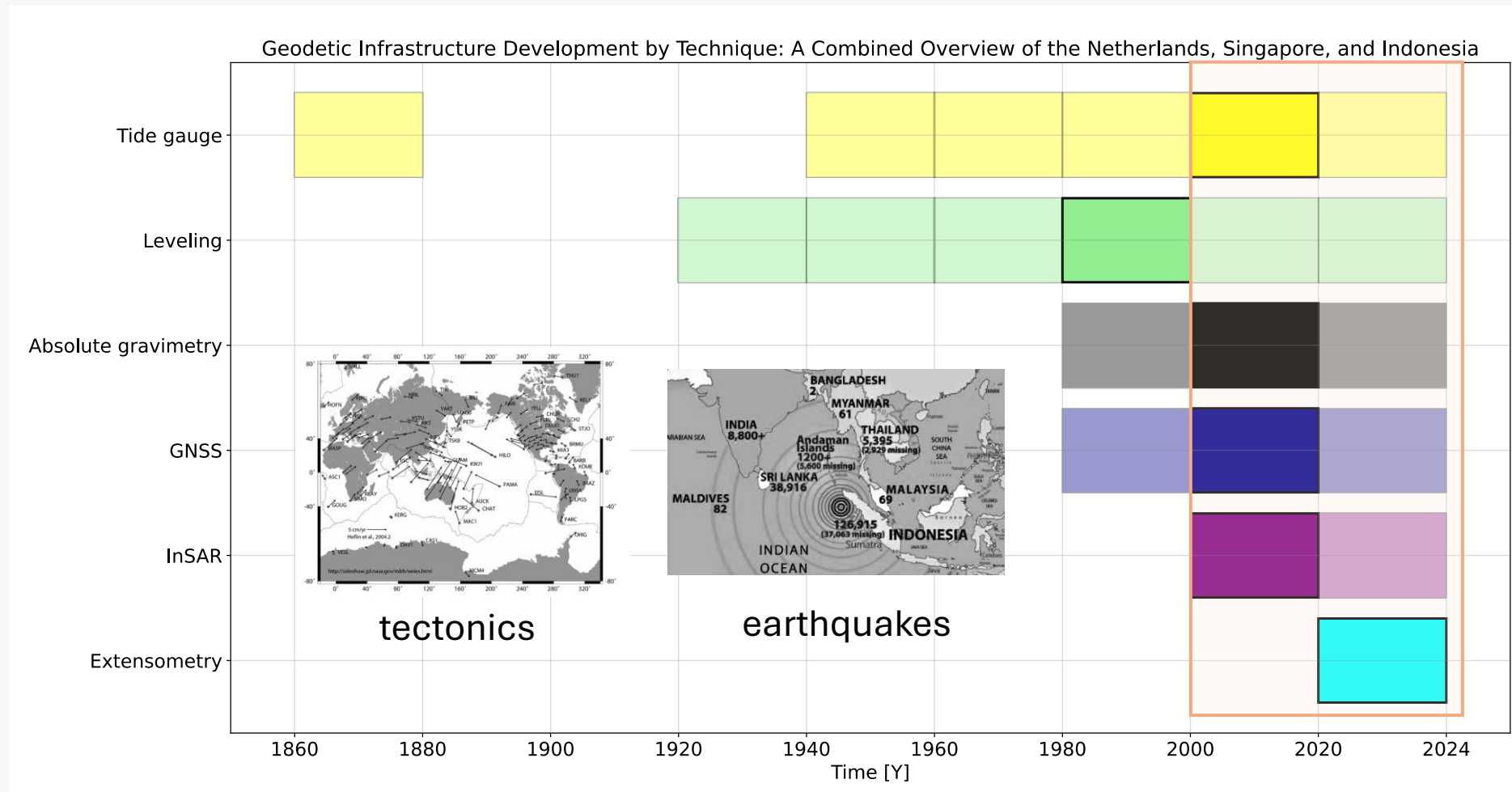

2000-2024: establishing continuous monitoring infrastructure to improve precision, reduce costs, study dynamic processes and develop early warning systems.

Example of novel geodetic infrastructure & products

NL



Integrated Corner Reflectors



Radar transponders



Mahapatra, Pooja, et al. "InSAR datum connection using GNSS-augmented radar transponders." *Journal of Geodesy* 92 (2018): 21-32.

National Subsidence map

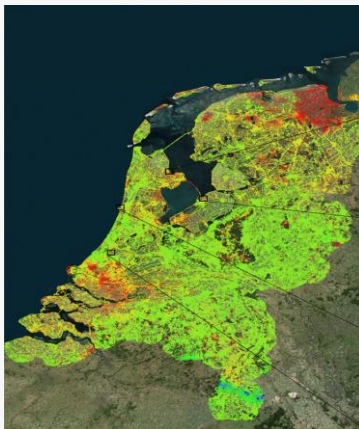

SG



National DEM & Orthophoto plan



Courtesy to : Singapore Land Authority

ID

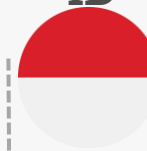

Extensometers



350 m deep



H. Andreas, 2024. Establishing Monitoring System of Land Subsidence and Coastal Inundation in Case Study Jakarta

National Geoid model

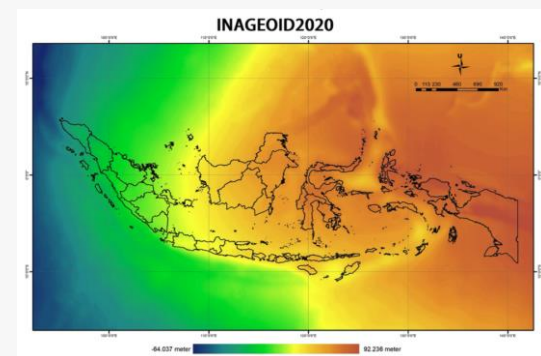

Capabilities: Techniques & Infrastructure → **Datum Problem**

The problem of different datums

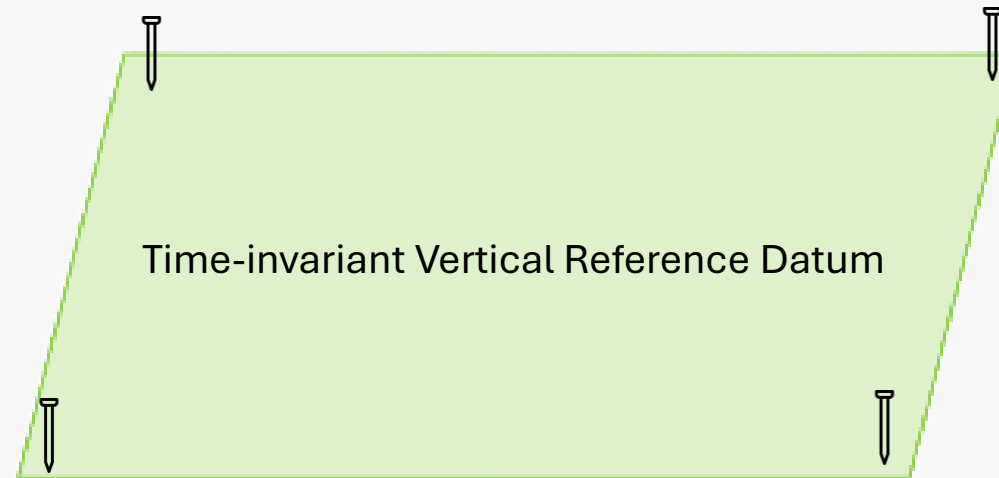

NL: NAP (1682)

SG: SHD (1934.5)

ID: JKVN (1985)

The problem of different datums

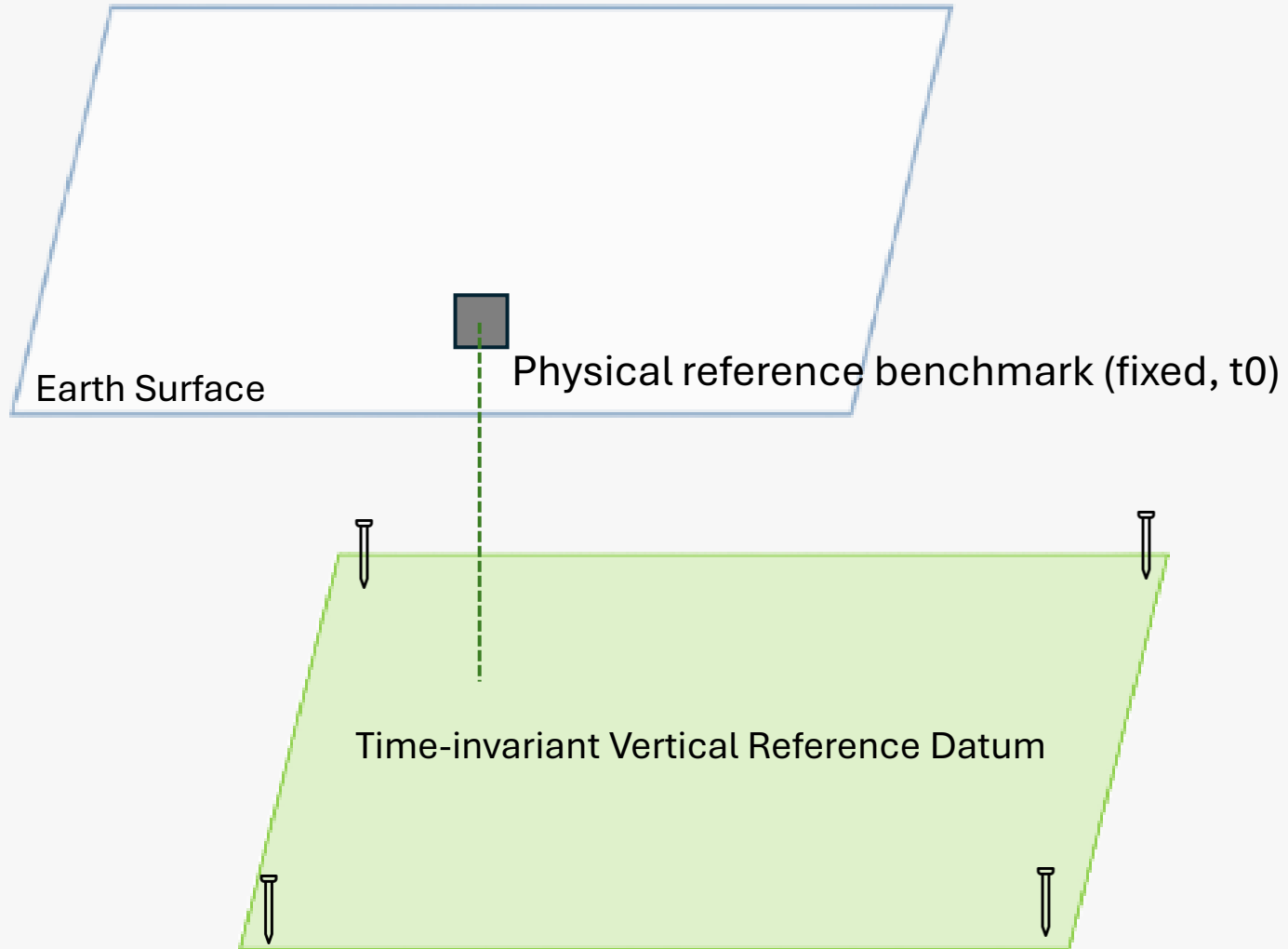

The problem of different datums

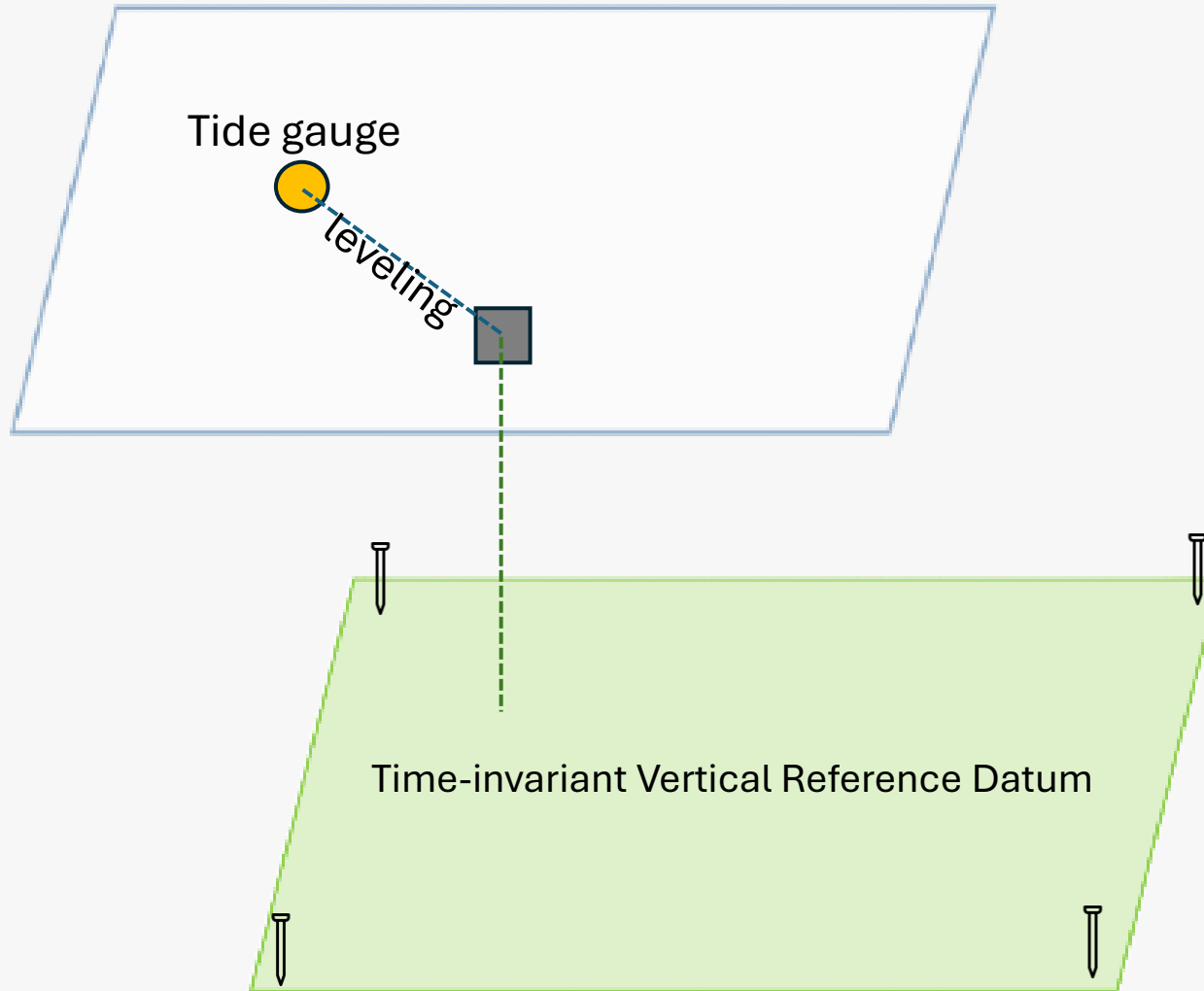

The problem of different datums

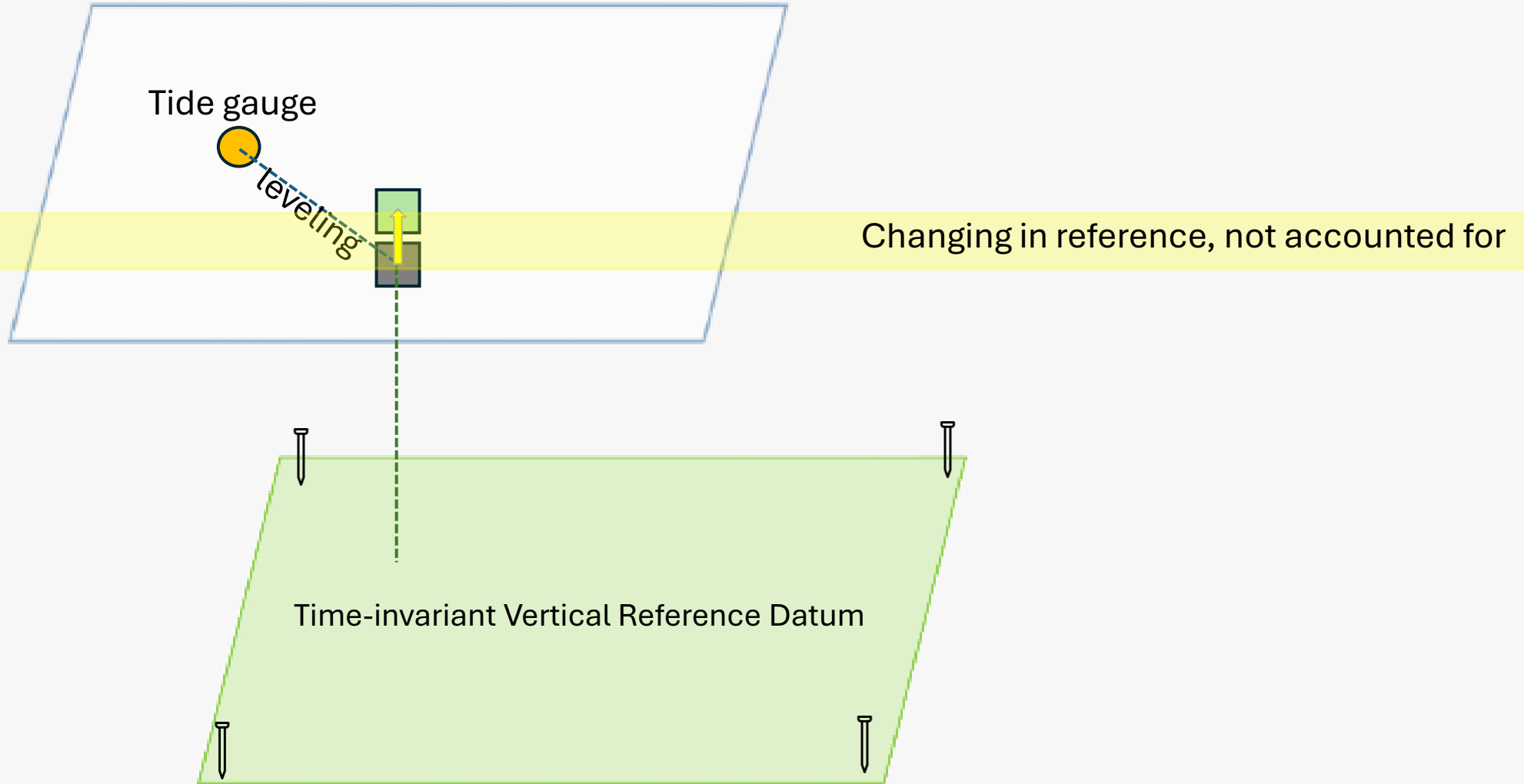

The problem of different datums

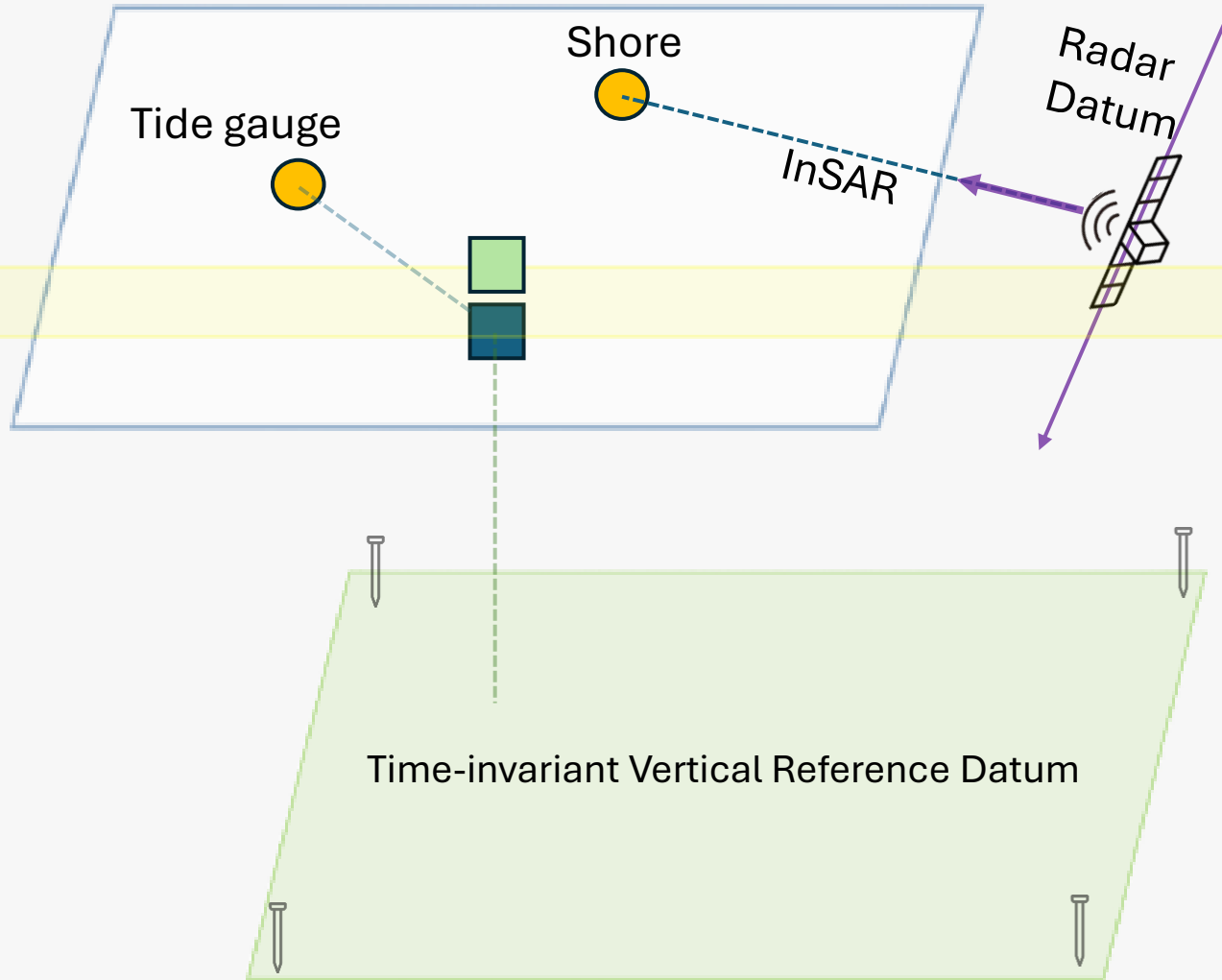

The problem of different datums

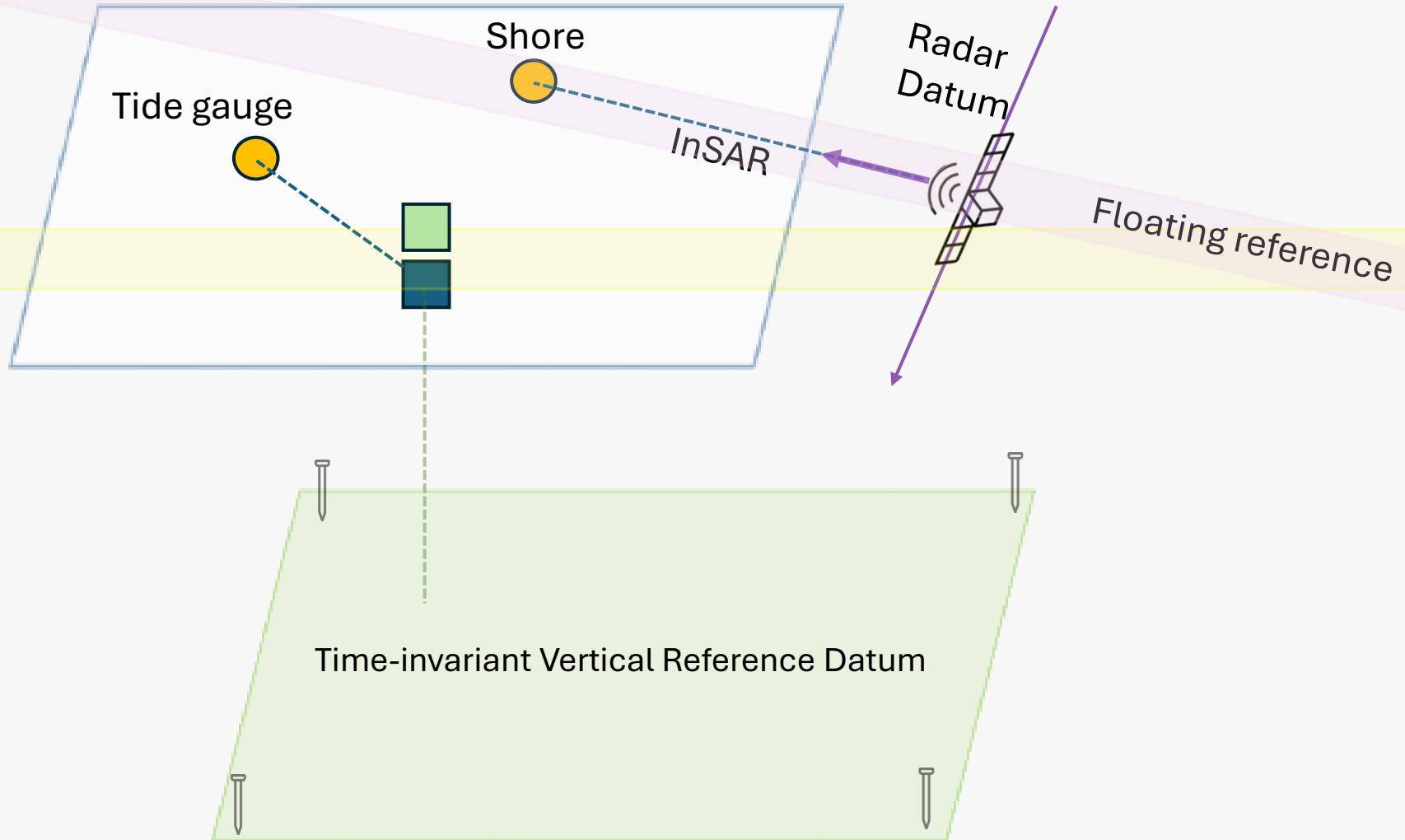

The problem of different datums

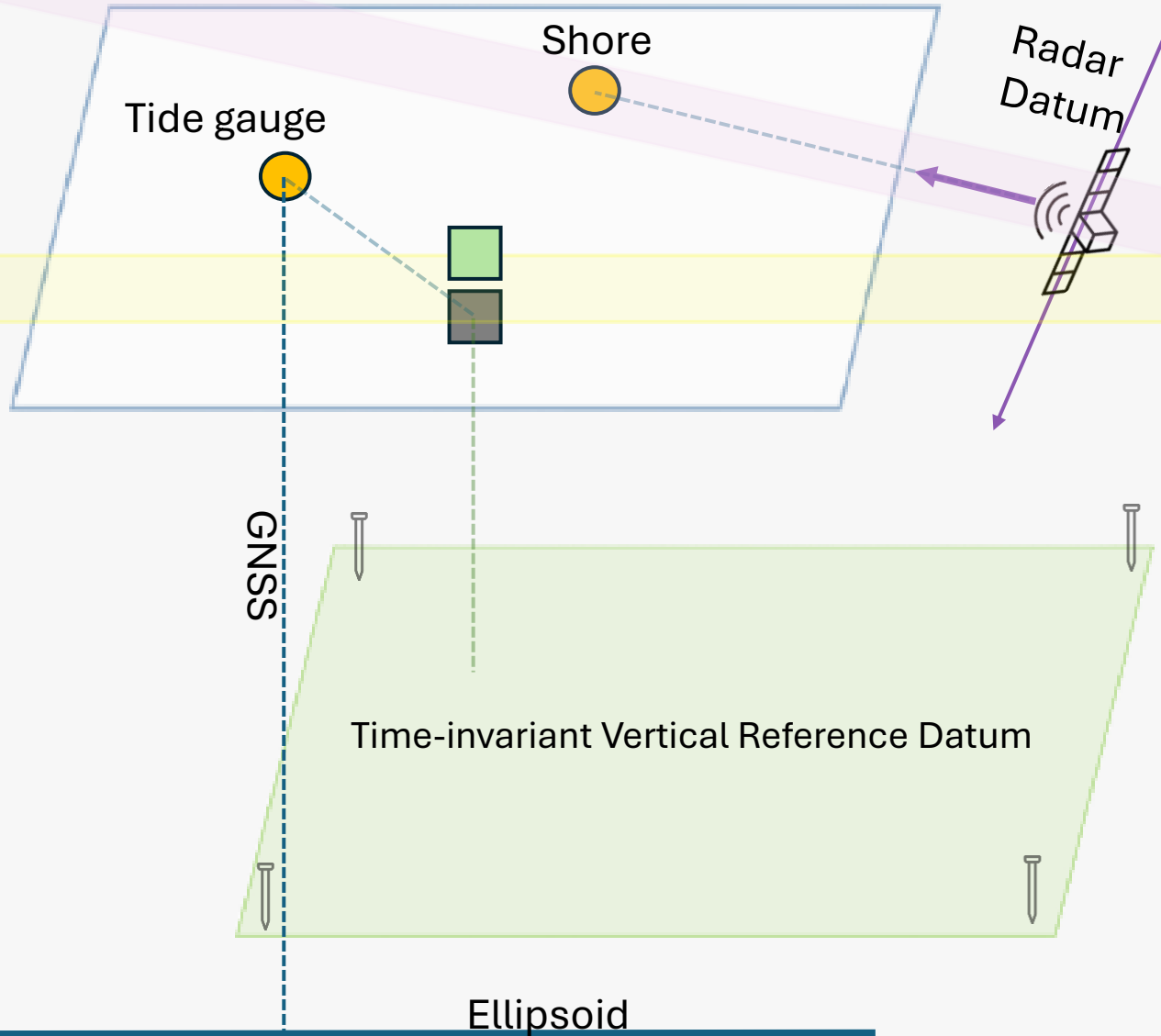

The problem of different datums

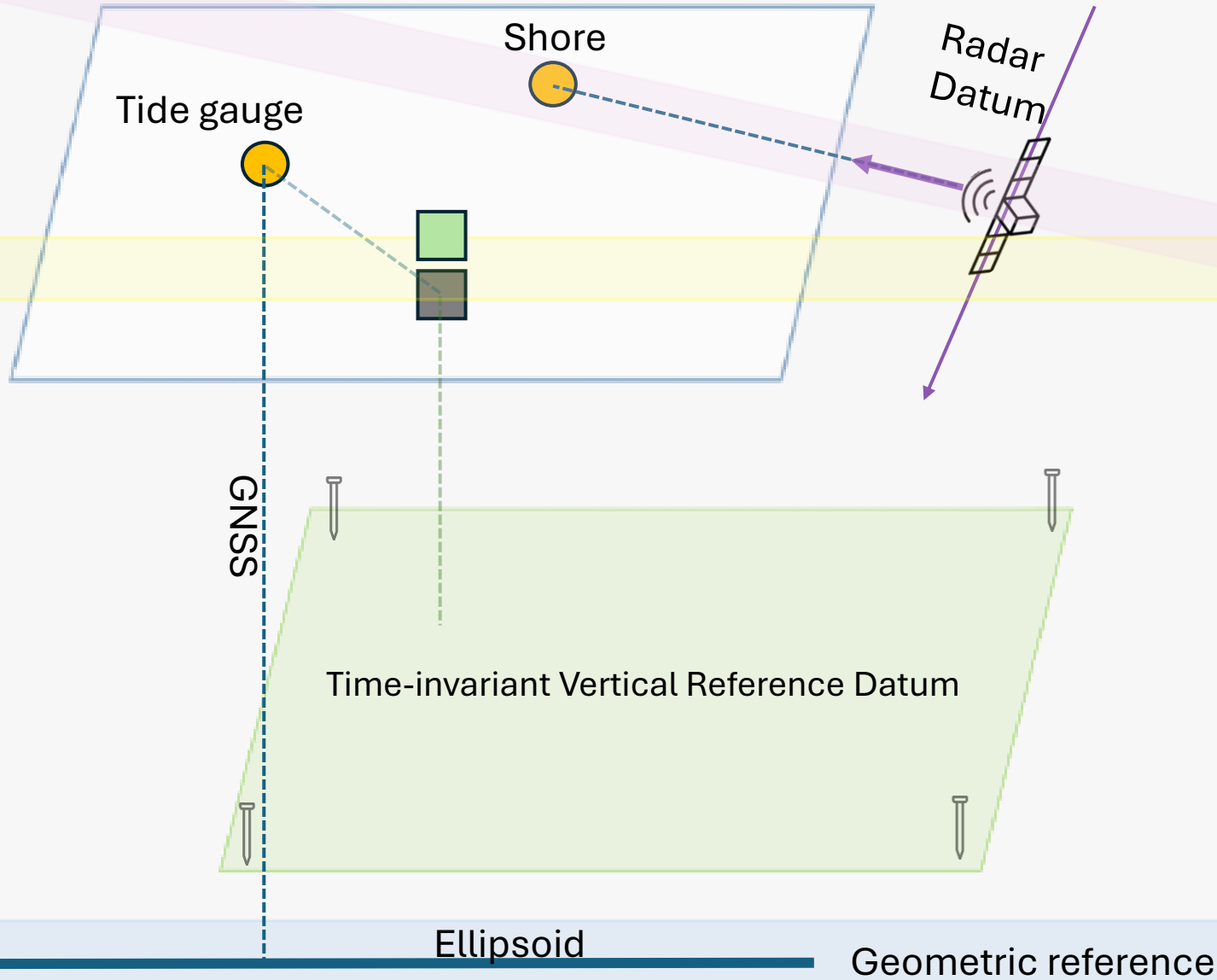

The problem of different datums

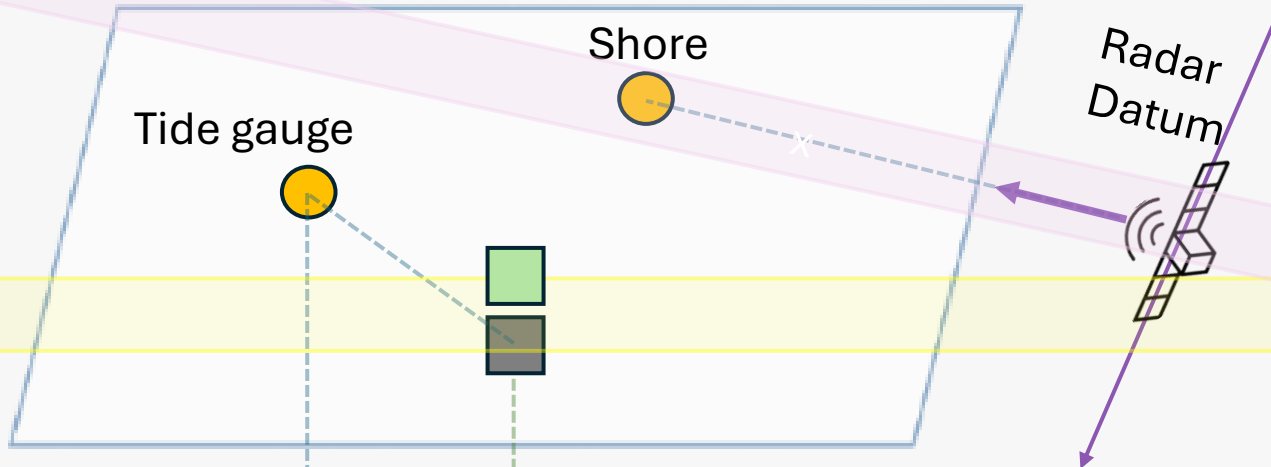

How do we connect?

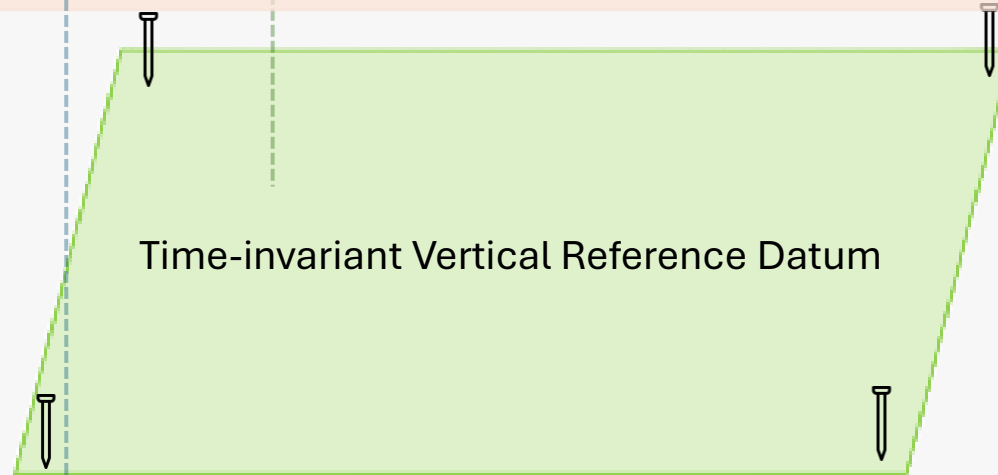

Time-variant Ellipsoid

Capabilities: Techniques & Infrastructure → Datum Problem → **Solutions**

Historic data

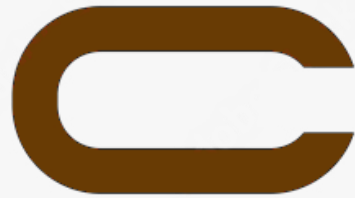

Past

Continuous monitoring



Present

Solutions: link to physical interpretable reference points!

The Integrated Geodetic Reference Station (IGRS)

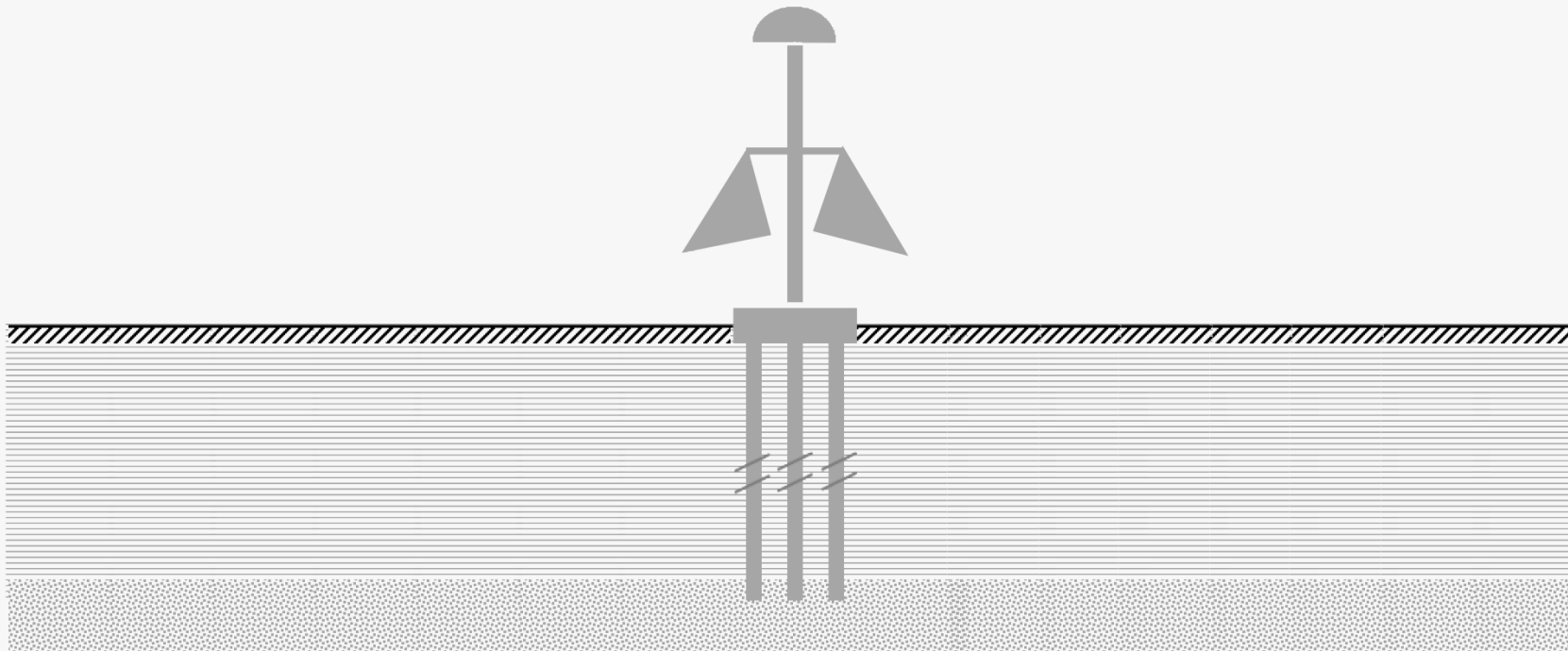

Provides the opportunity to **integrate** multiple geodetic techniques to the **same point** in space, which is **continuously monitored**.

Solutions: link to physical interpretable reference points!

The Integrated Geodetic Reference Station (IGRS)

Spirit leveling

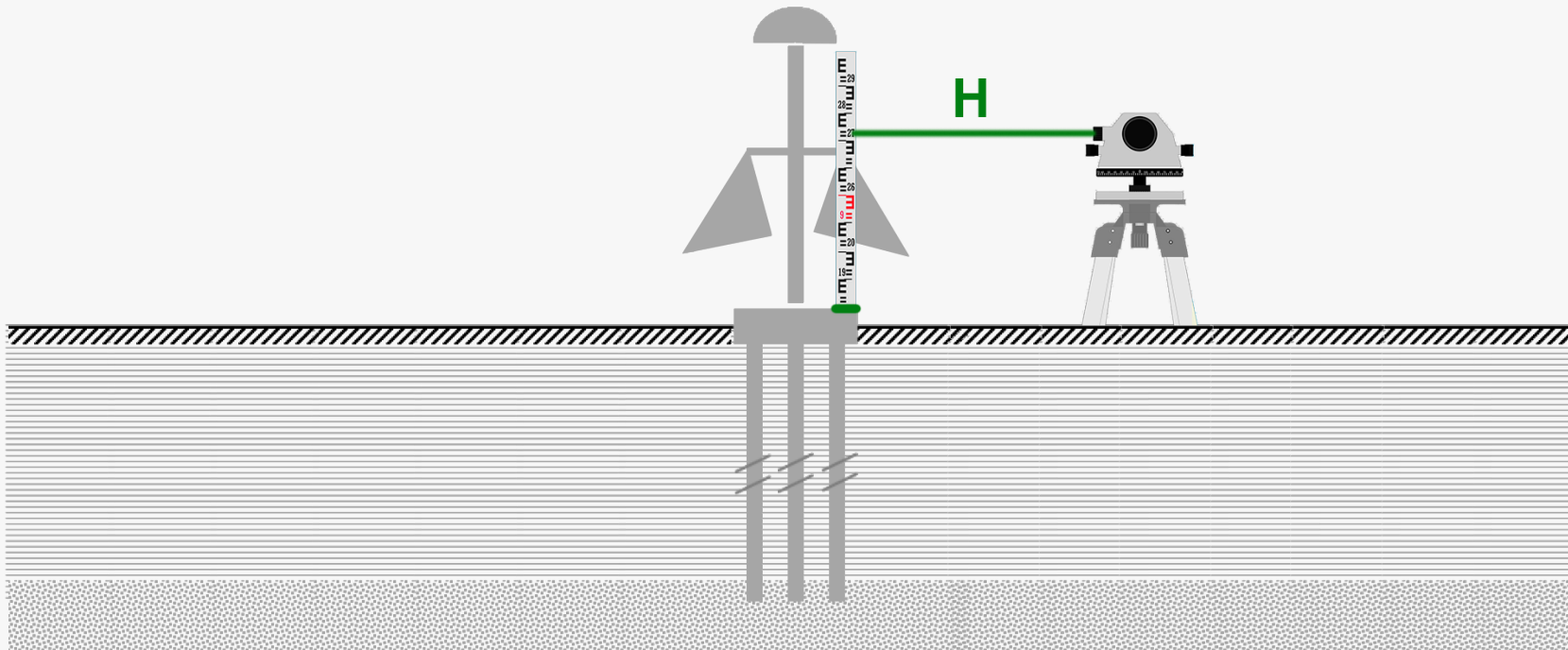

Solutions: link to physical interpretable reference points!

The Integrated Geodetic Reference Station (IGRS)

LiDAR

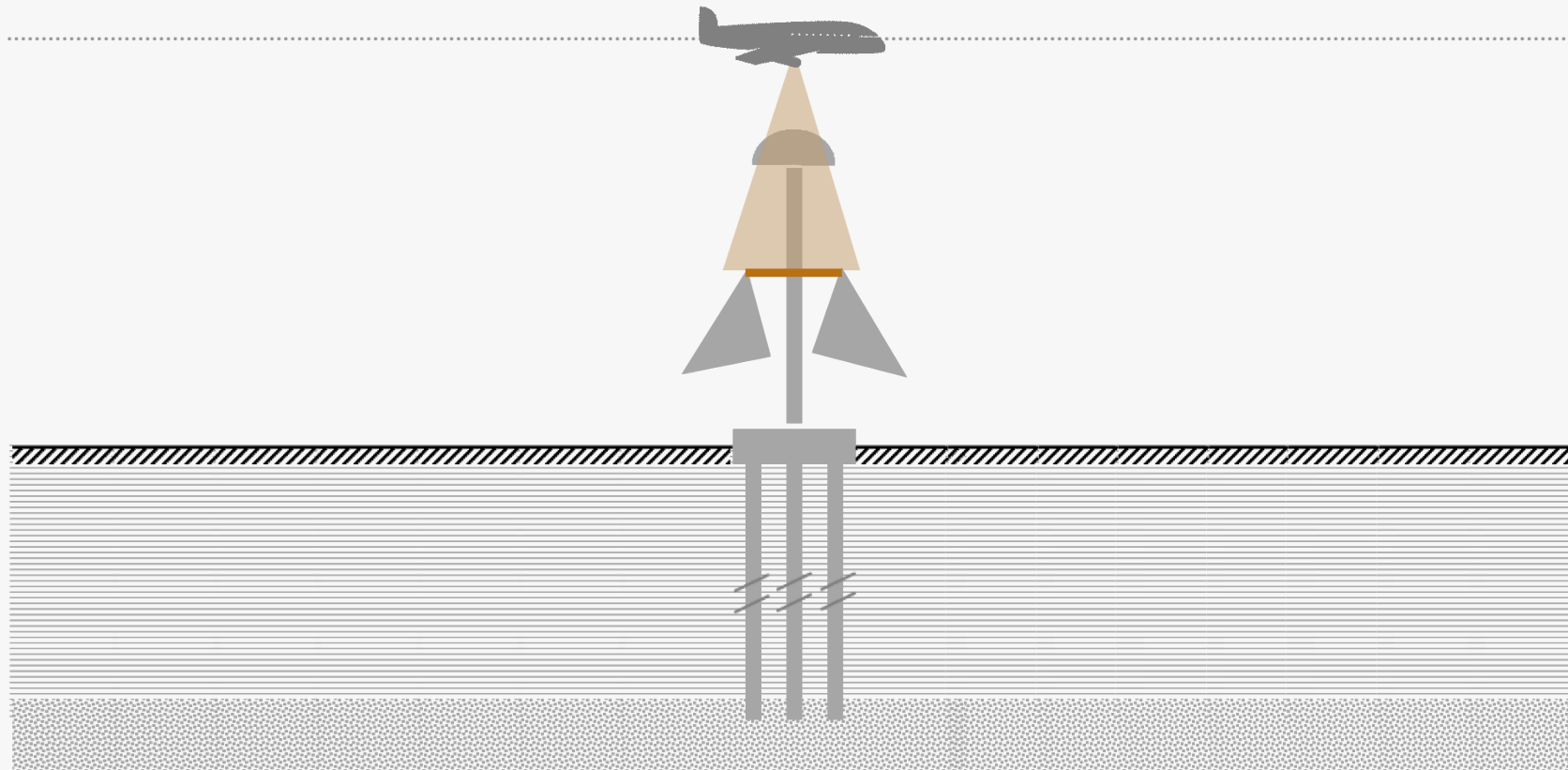

Solutions: link to physical interpretable reference points!

The Integrated Geodetic Reference Station (IGRS)

InSAR

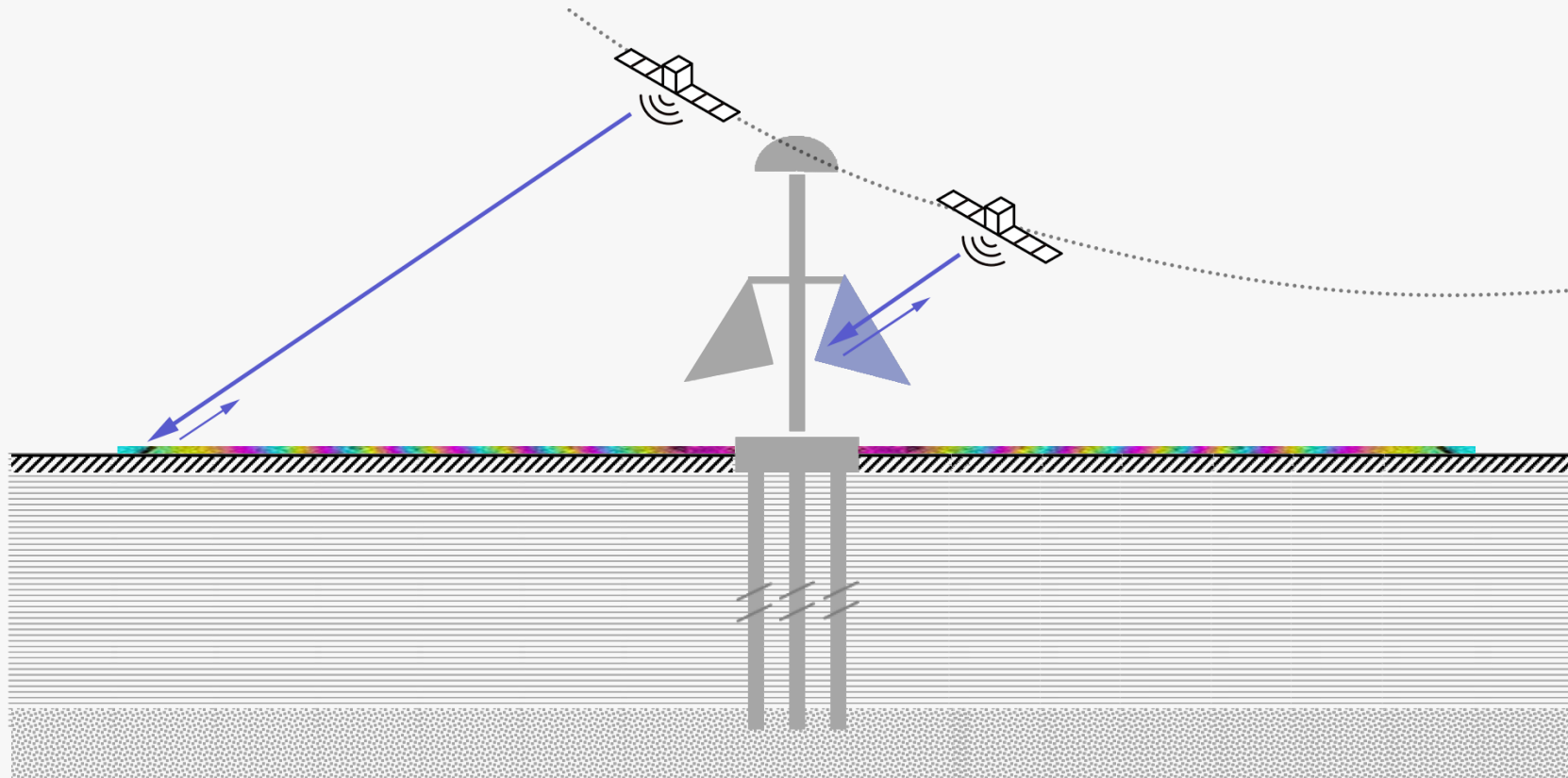

Solutions: link to physical interpretable reference points!

The Integrated Geodetic Reference Station (IGRS)

GNSS

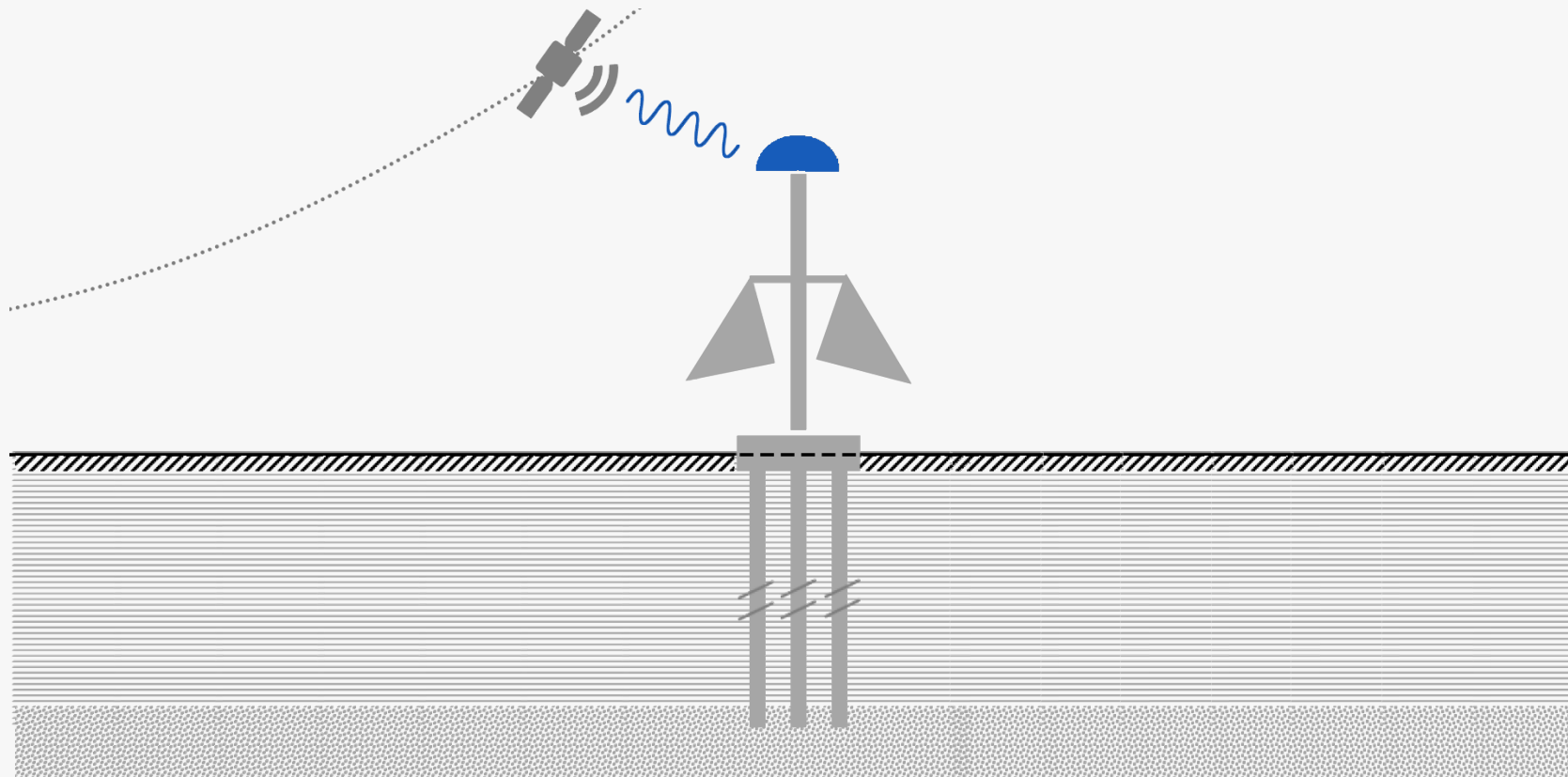

Solutions: link to physical interpretable reference points!

The Integrated Geodetic Reference Station (IGRS)

GNSS

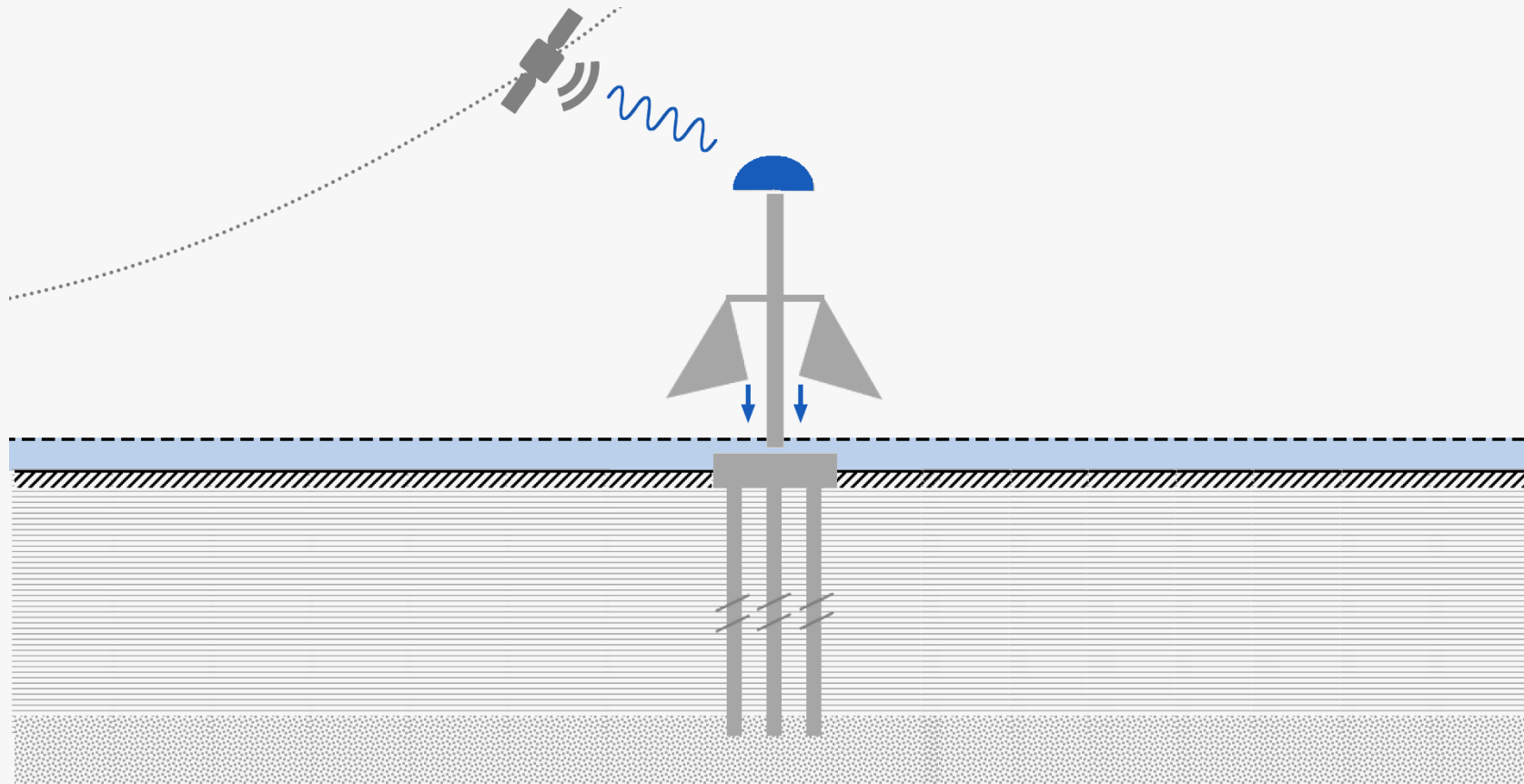

Solutions: in the future more integrated infrastructure

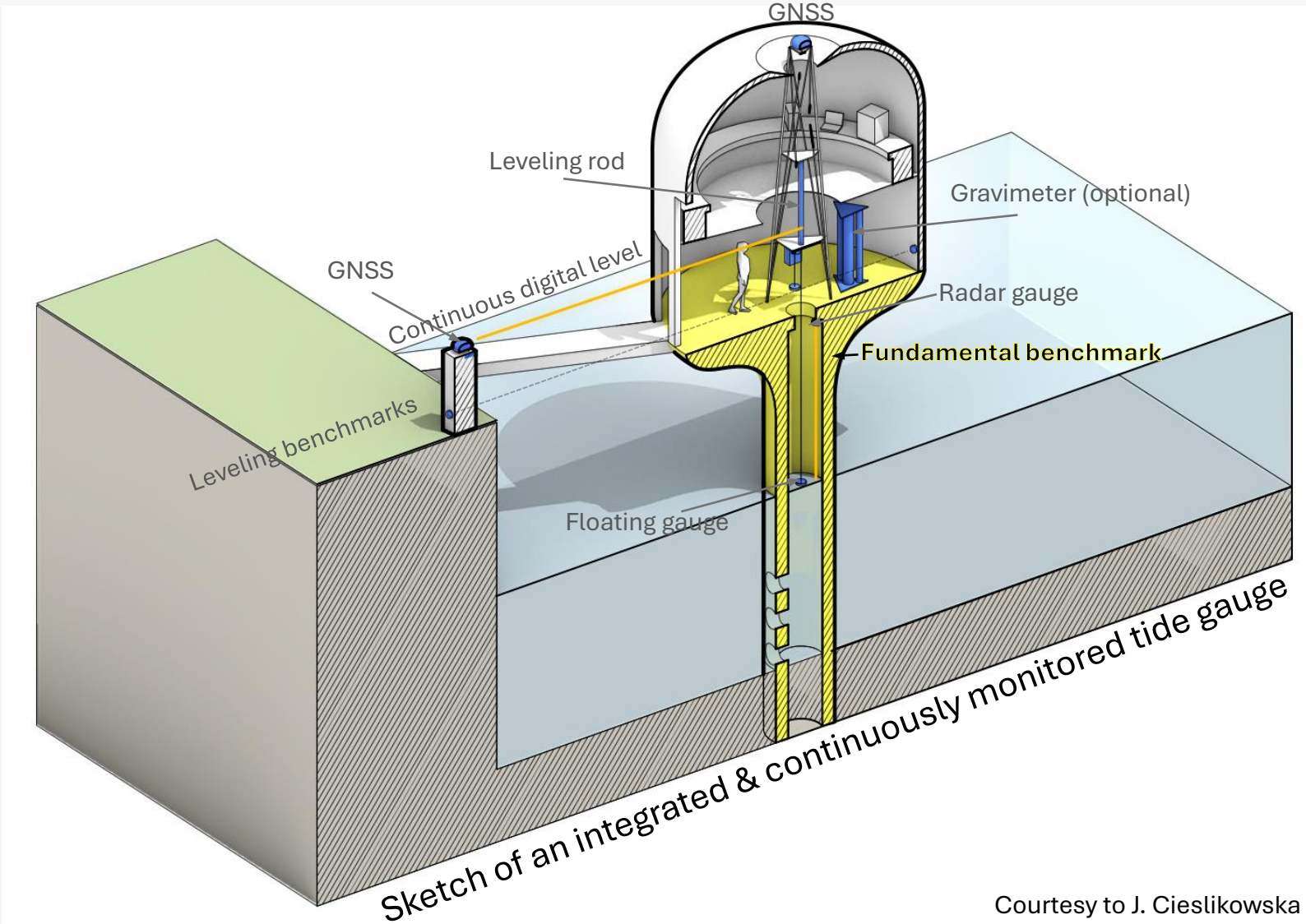

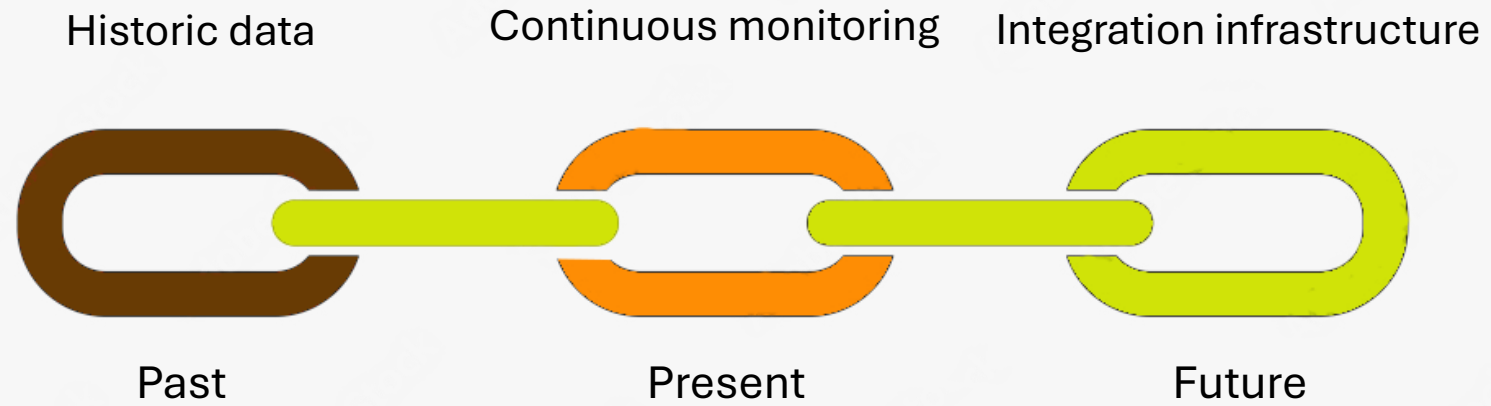

Capabilities: Techniques & Infrastructure → Datum Problem → Solutions → **Conclusions**

Conclusions

We have remarkable geodetic infrastructure,
but geodetic techniques work in **independent Datums!**

Conclusions

We have remarkable geodetic infrastructure,
but geodetic techniques work in **independent Datums!**

The vision for enabling dynamic monitoring:

- Establish **continuously monitored physical benchmarks** and **methods** for technique connection.

Conclusions

We have remarkable geodetic infrastructure,
but geodetic techniques work in **independent Datums!**

The vision for enabling dynamic monitoring:

- Establish **continuously monitored physical benchmarks** and **methods** for technique connection.

Looking Ahead:

- **Build** and **maintain integrated infrastructure** to study vertical land motion and separate it from sea level changes.

Conclusions

We have remarkable geodetic infrastructure,
but geodetic techniques work in **independent Datums!**

The vision for enabling dynamic monitoring:

- Establish **continuously monitored physical benchmarks** and **methods** for technique connection.

Looking Ahead:

- **Build** and **maintain integrated infrastructure** to study vertical land motion and separate it from sea level changes.

From fragmented frameworks to unified solutions—integrated geodesy for generations.